

WTVF-VF1-V1.1-5

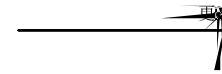

恒达富士电梯  
有









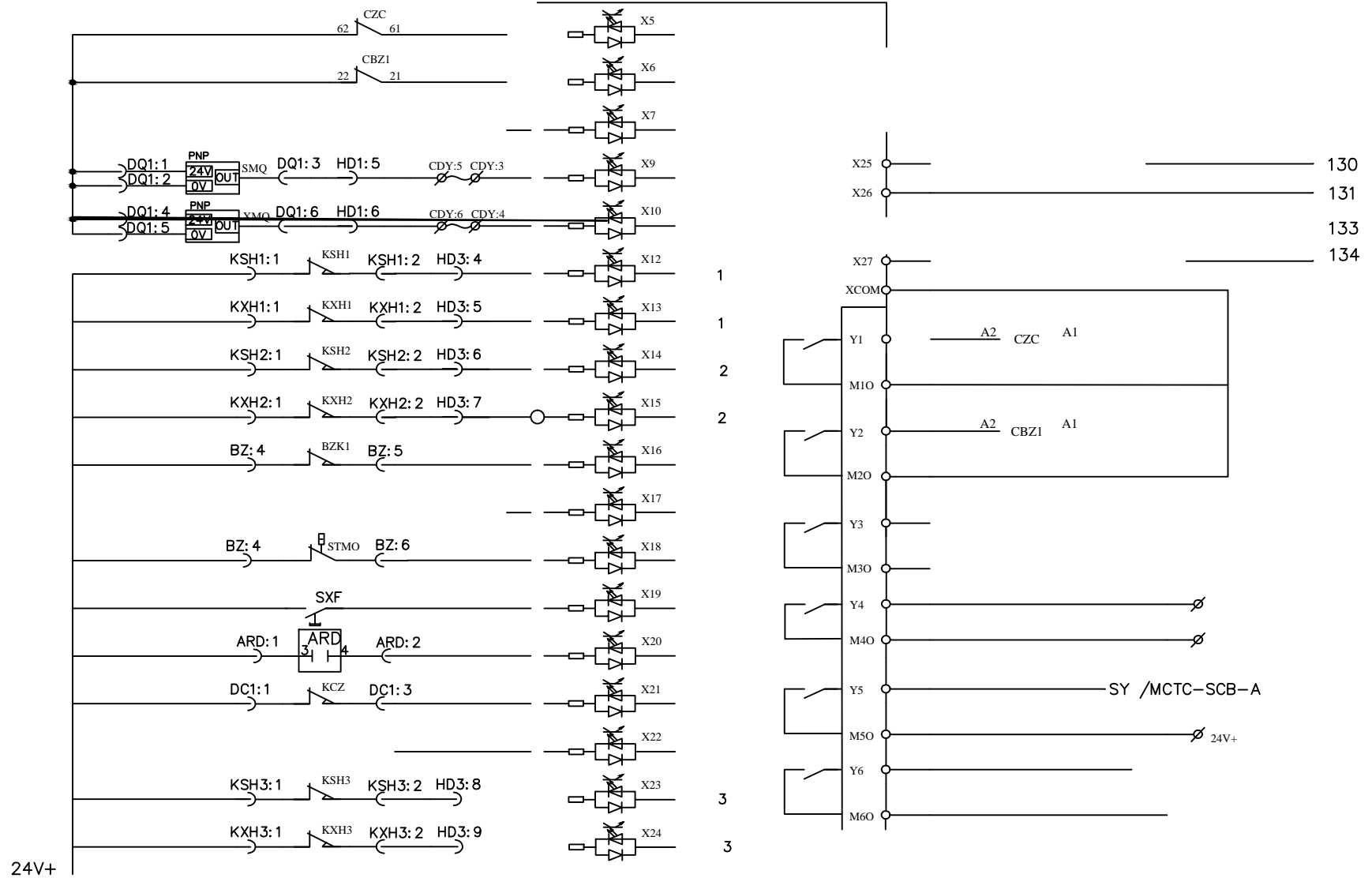

FJ-MPU-V4.0

恒达富士电梯  
有

更改文件号

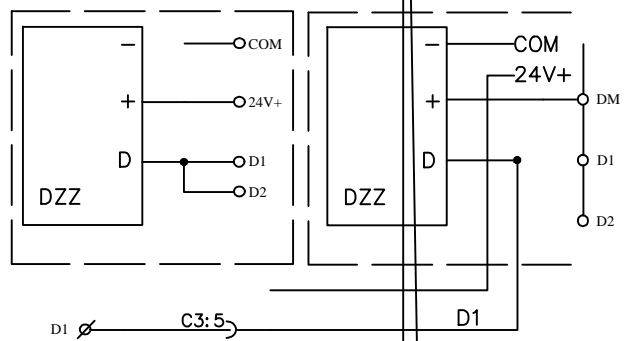
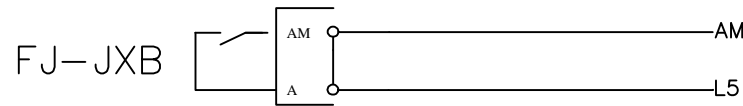
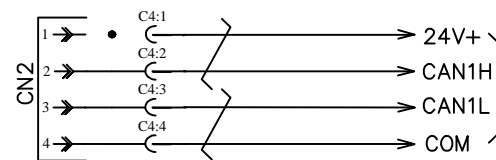
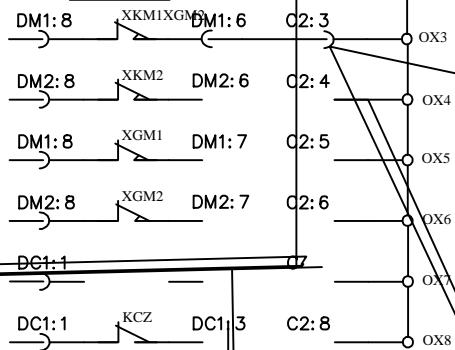
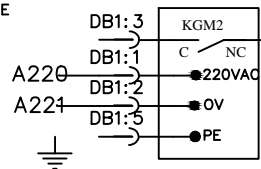
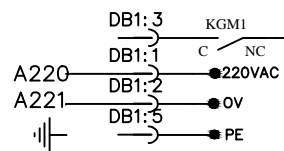

恒达富士电梯  
有

更改文件号

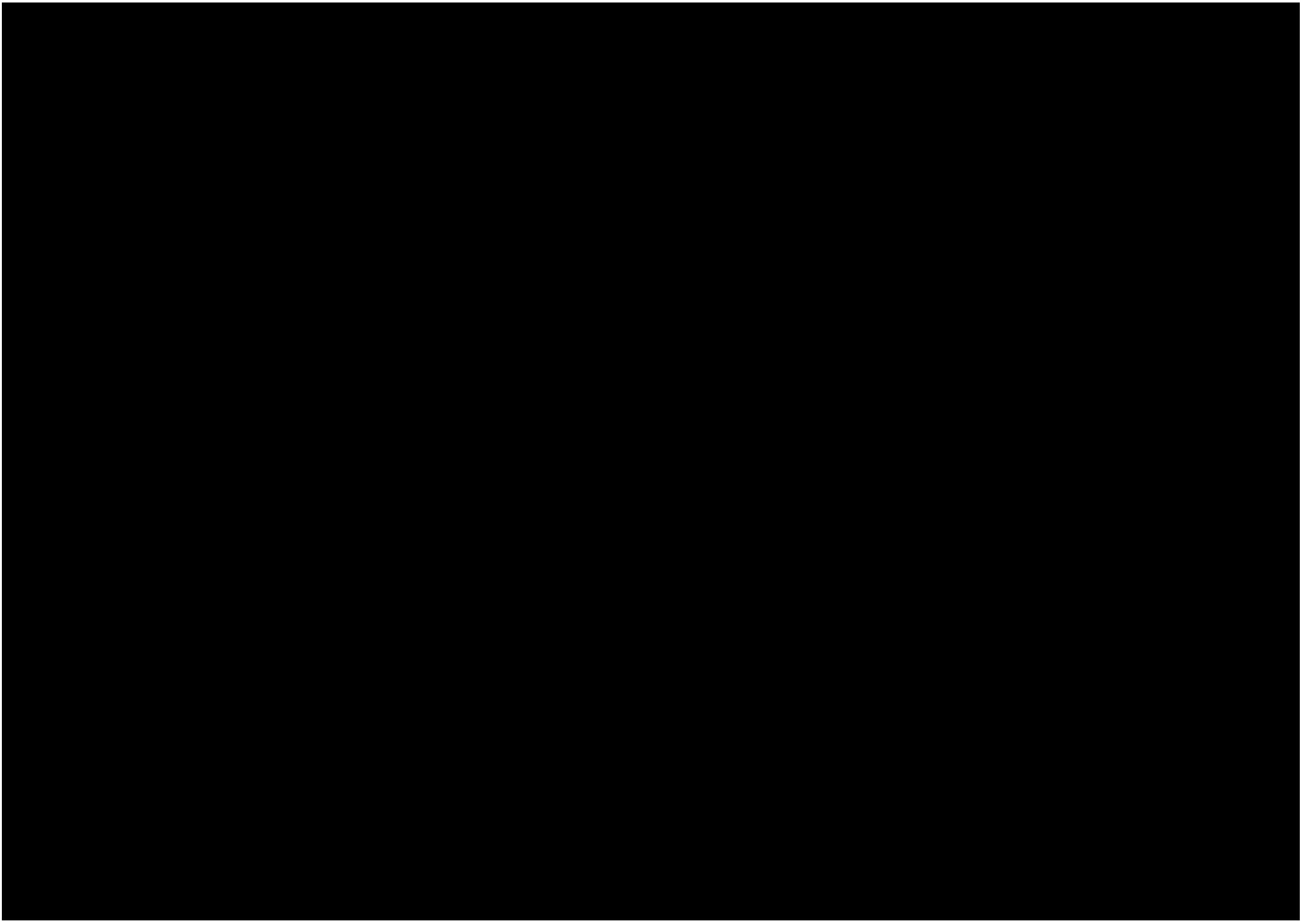







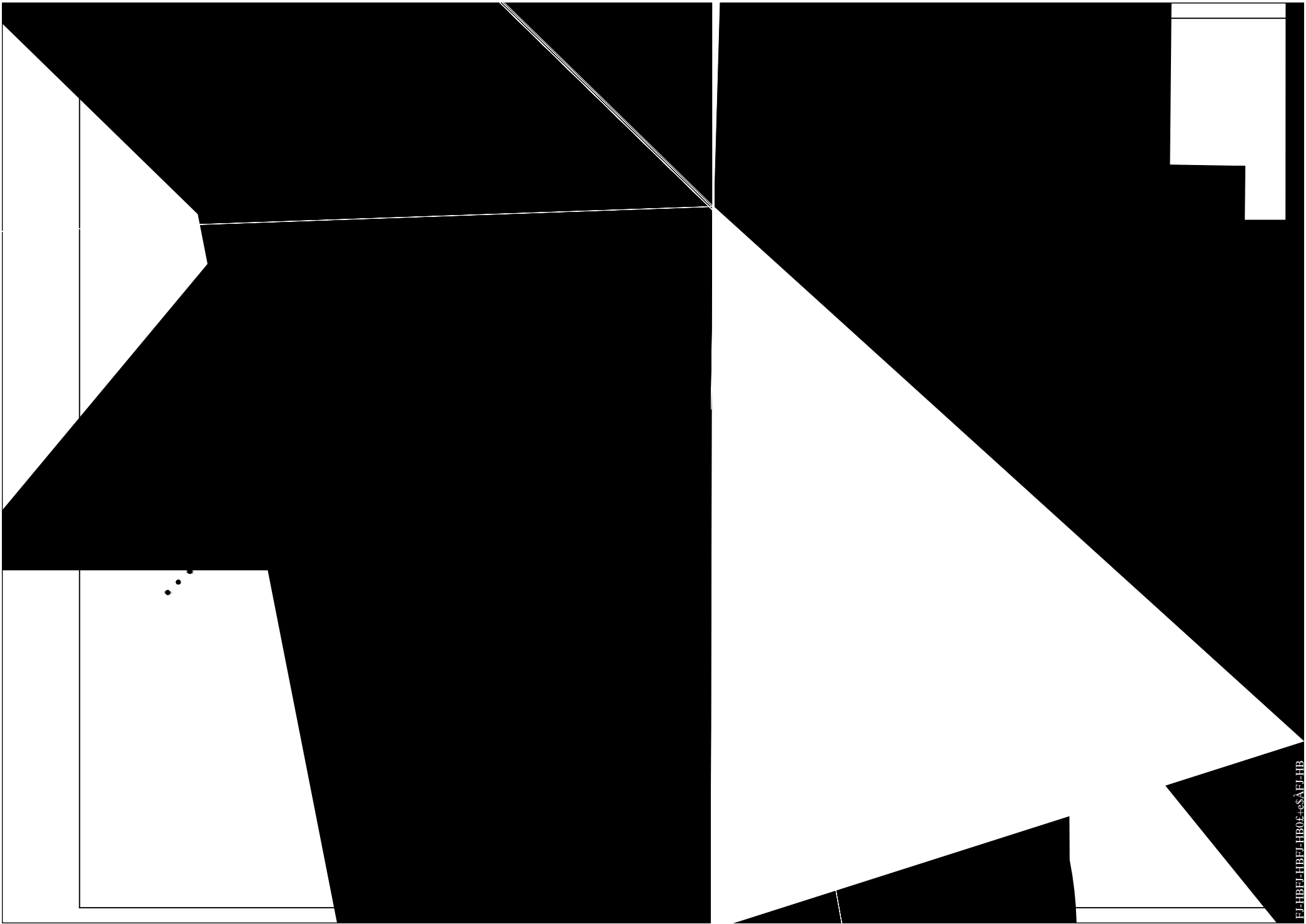

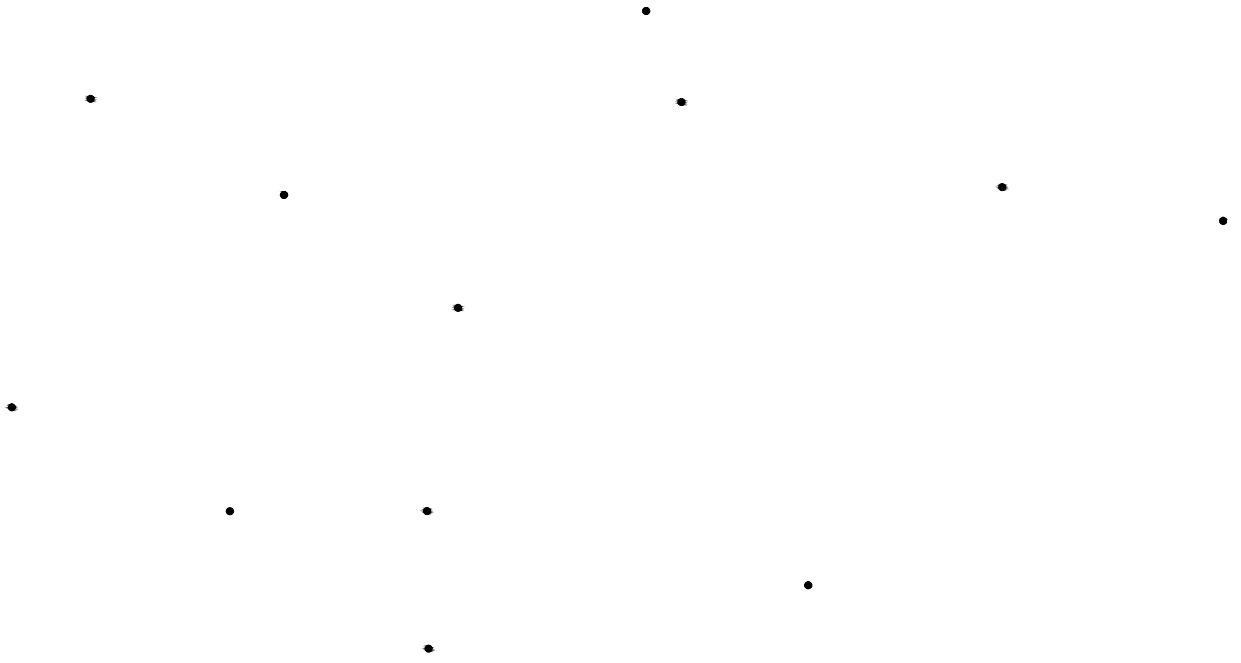
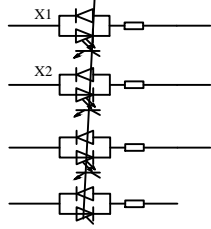

更改文件号

恒达富士电梯  
有





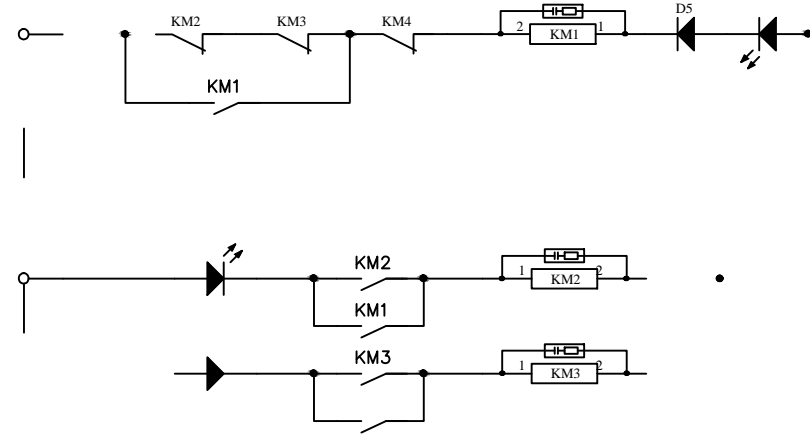

FJ-MPU-V4.0

恒达富士电梯  
有

标记	处数	分区	更改文件号	签名	年月日			
设计			标准化			阶段标识	重量	比例
校对								
审核								
工艺			批准			共 张	第 张	







A220 — HD2: 4 •

A221 — HD2: 5 •

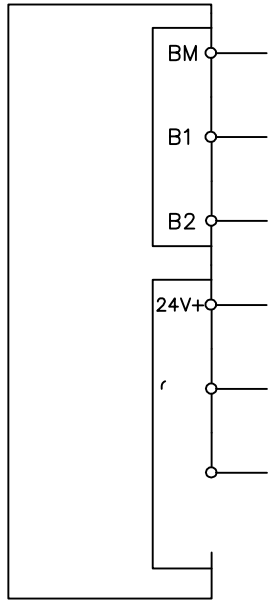

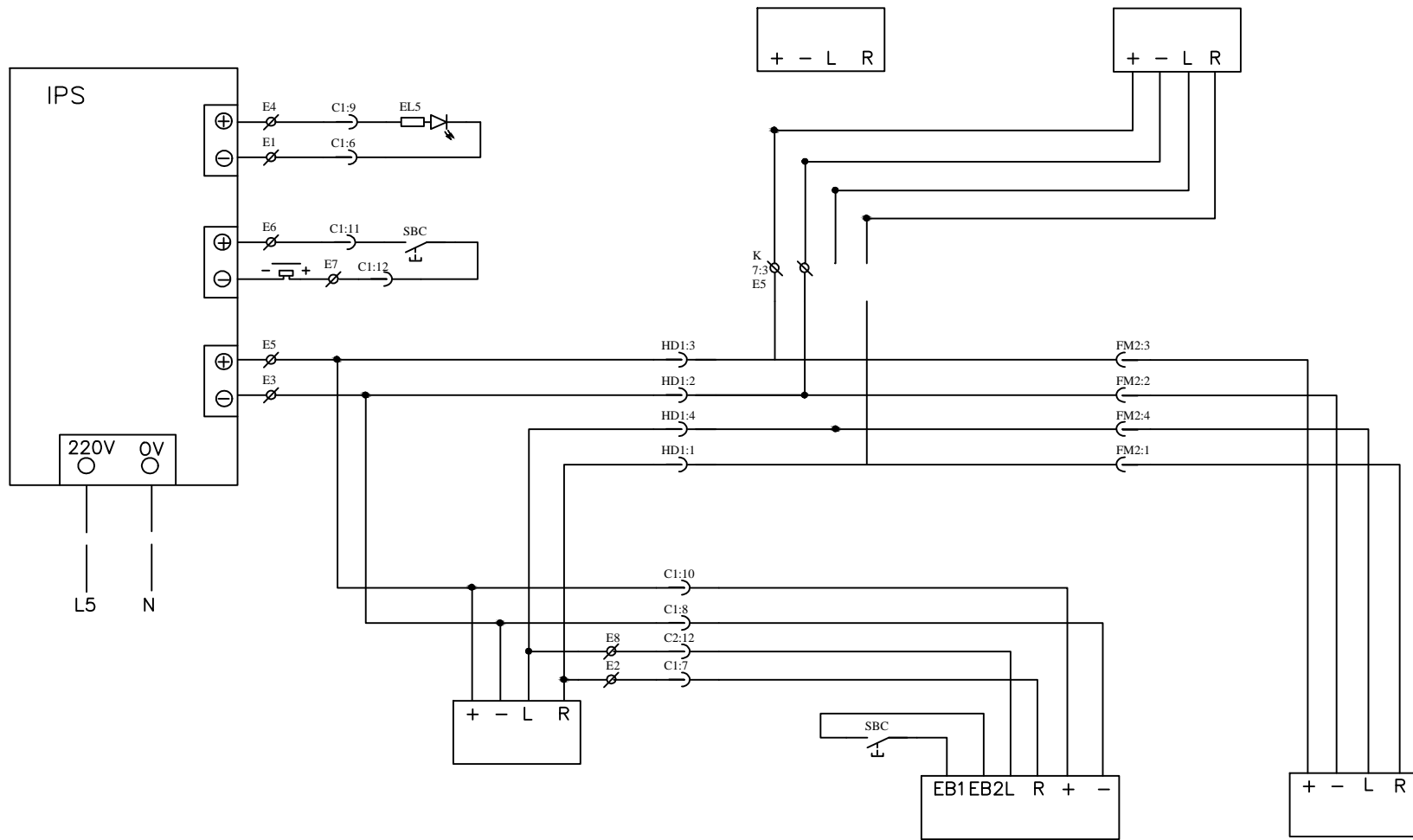

恒达富士电梯  
有

更改文件号



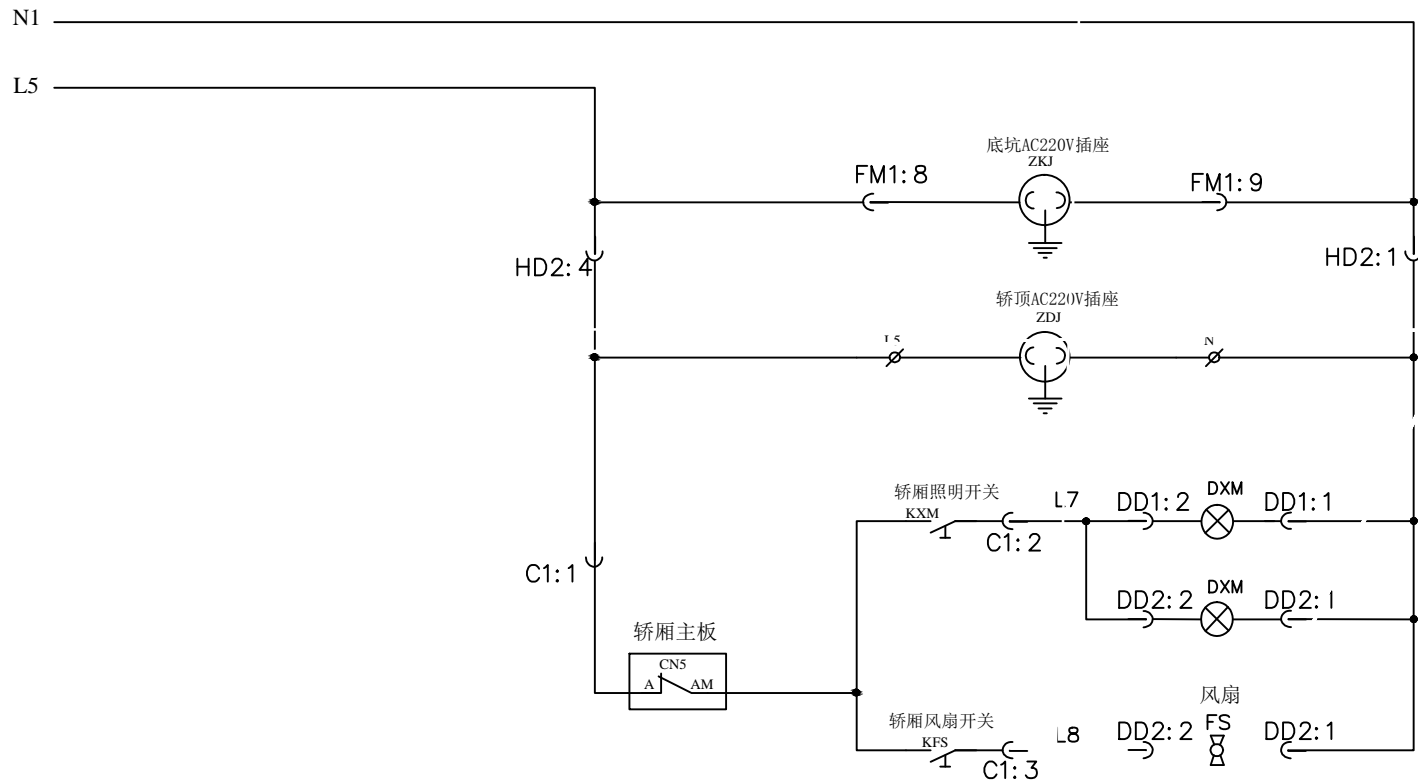

恒达富士电梯  
有

轿厢照明

标记 处数 分区 更改文件号 签名 年月日  
 设计 汪军 标准化 王爱敏 阶段标识 重量 比例  
 校对 沈丹  
 审核 吴伟国  
 工艺 严红星 批准 刘万兵 共28张 第20张

H1501000

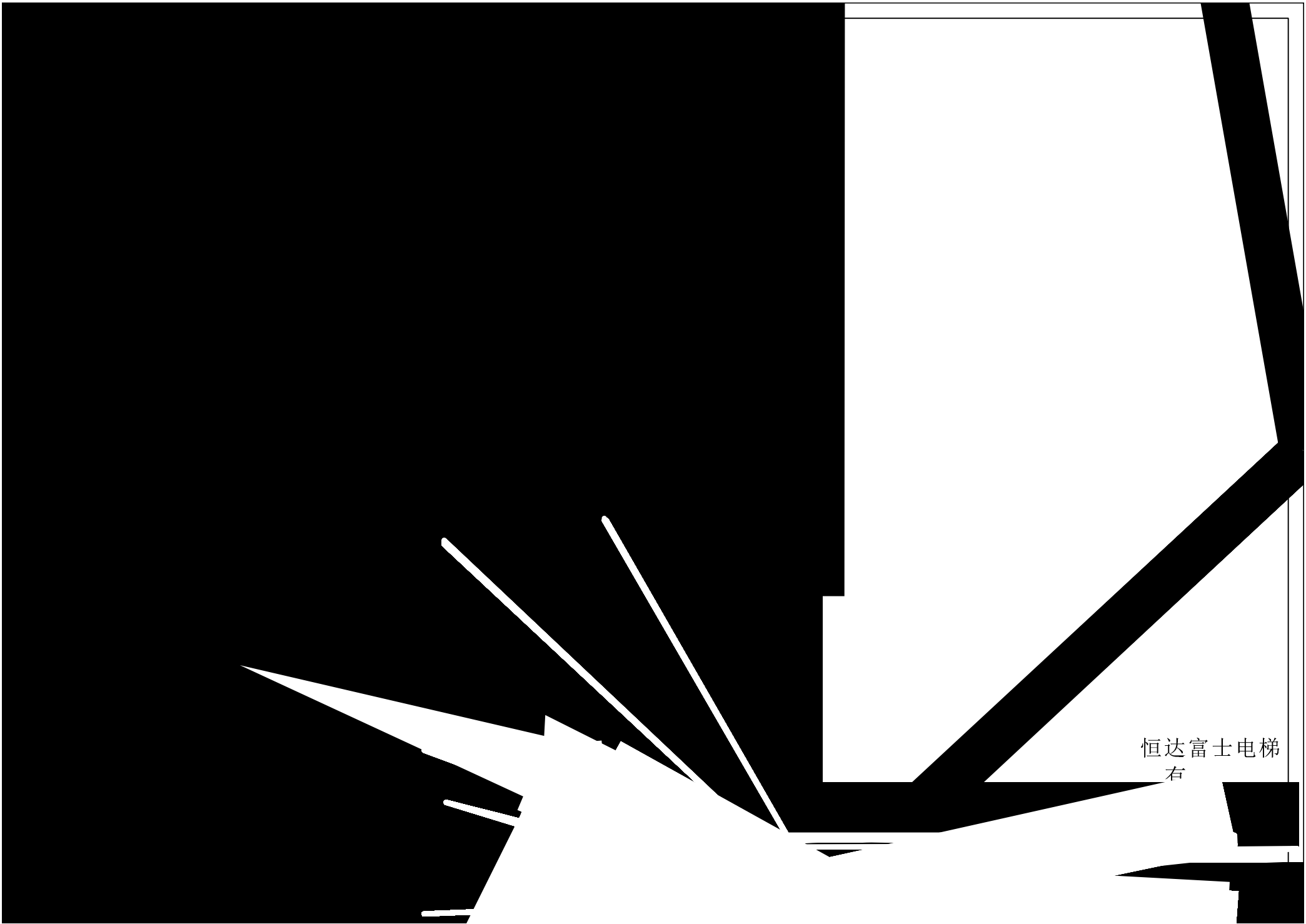

恒达富士电梯  
右

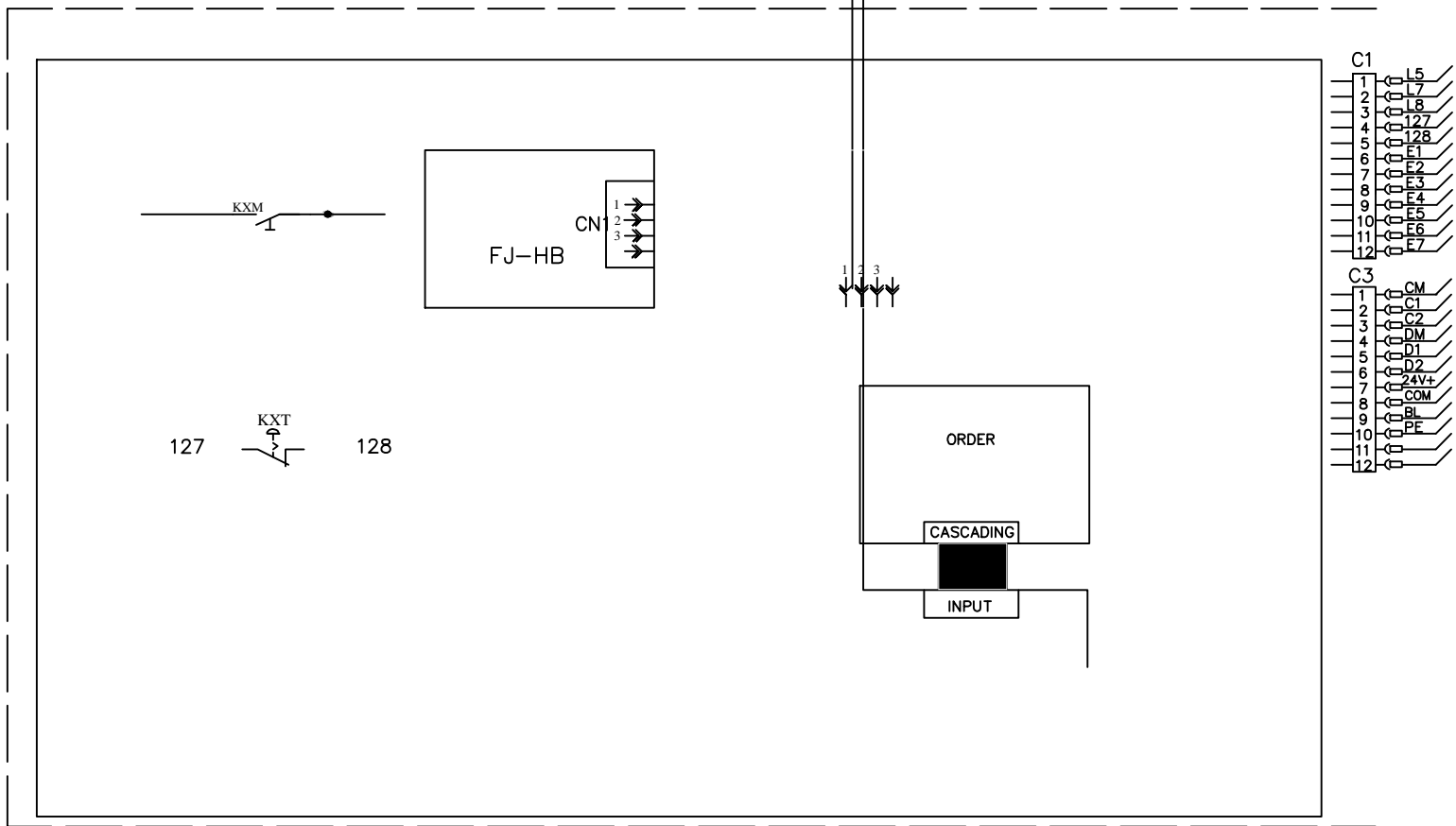

恒达富士电梯  
有

更改文件号

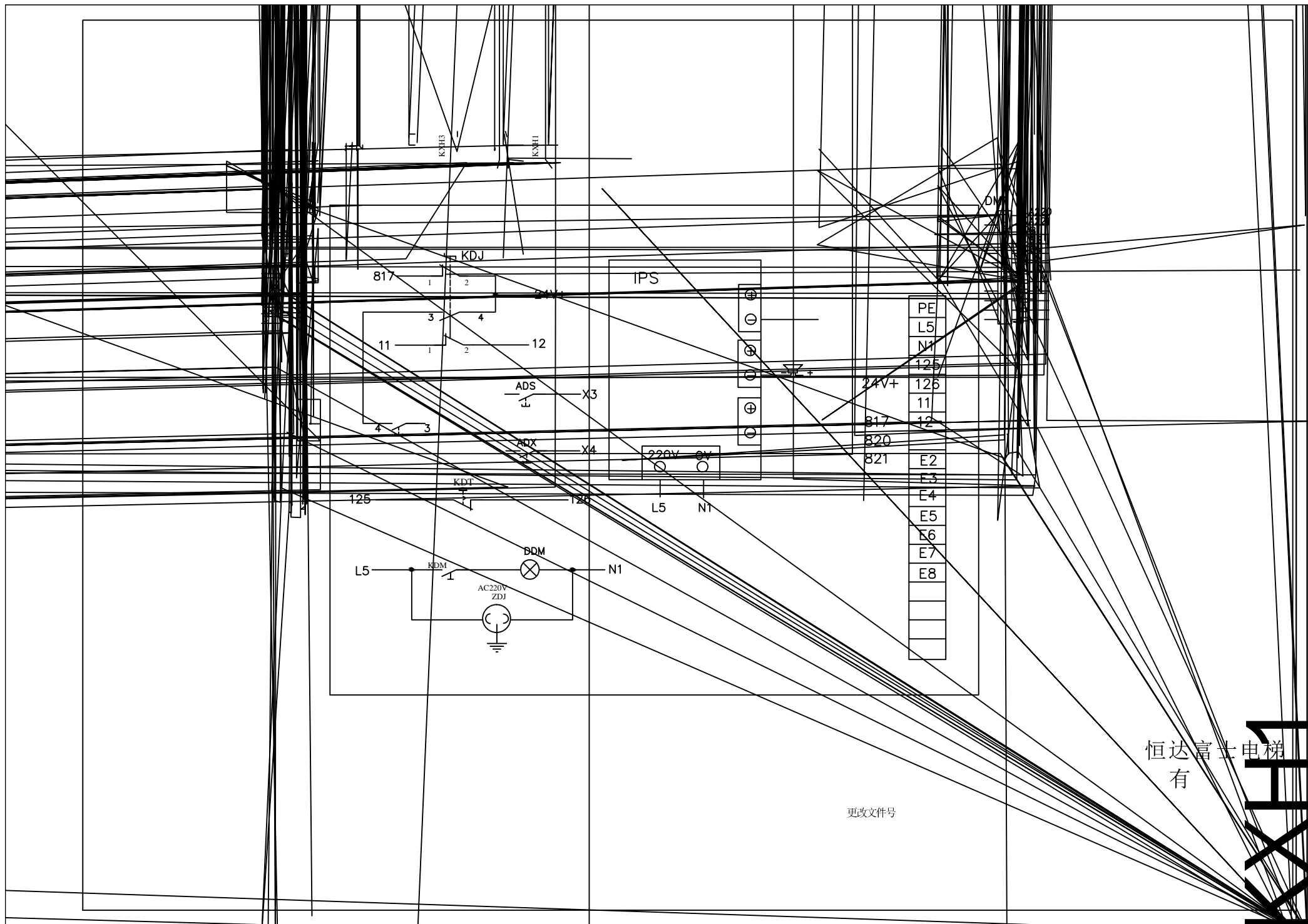

恒达富士电梯  
有

更改文件号

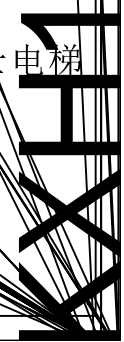



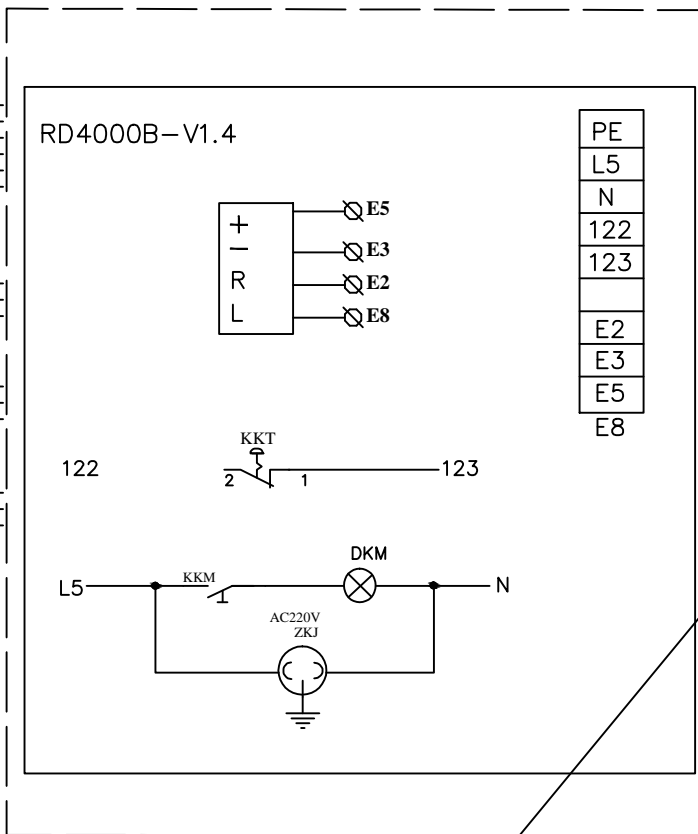
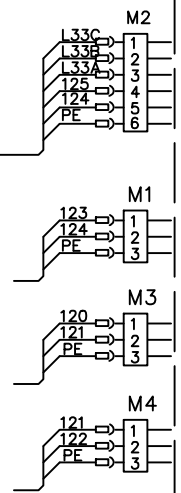
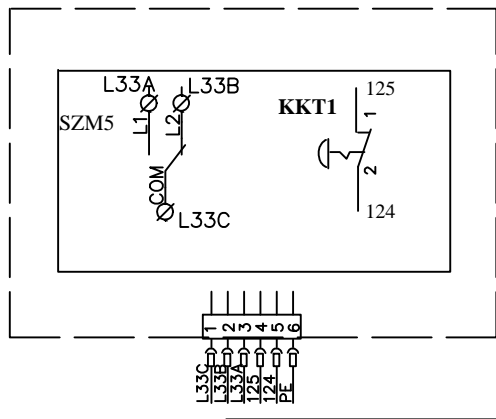

恒达富士电梯  
有

更改文件号



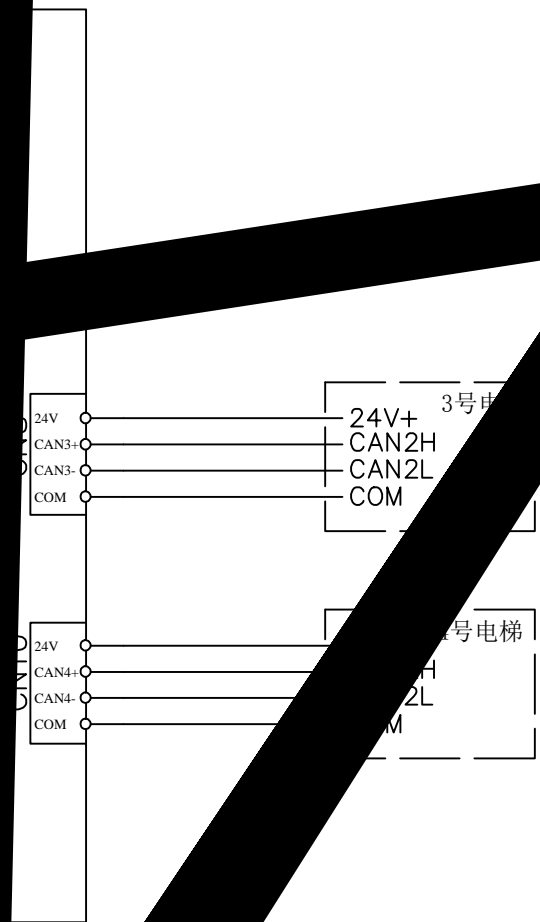
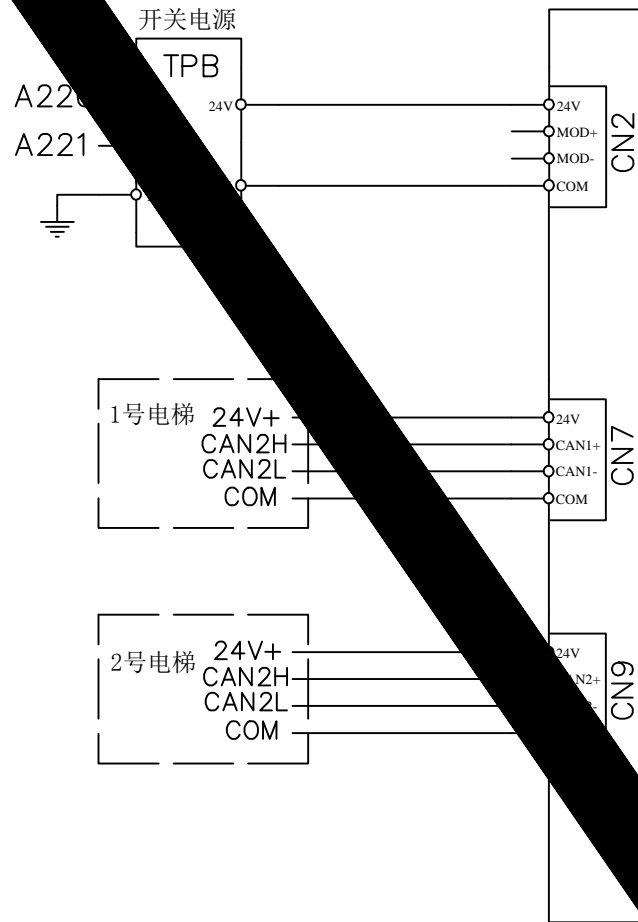

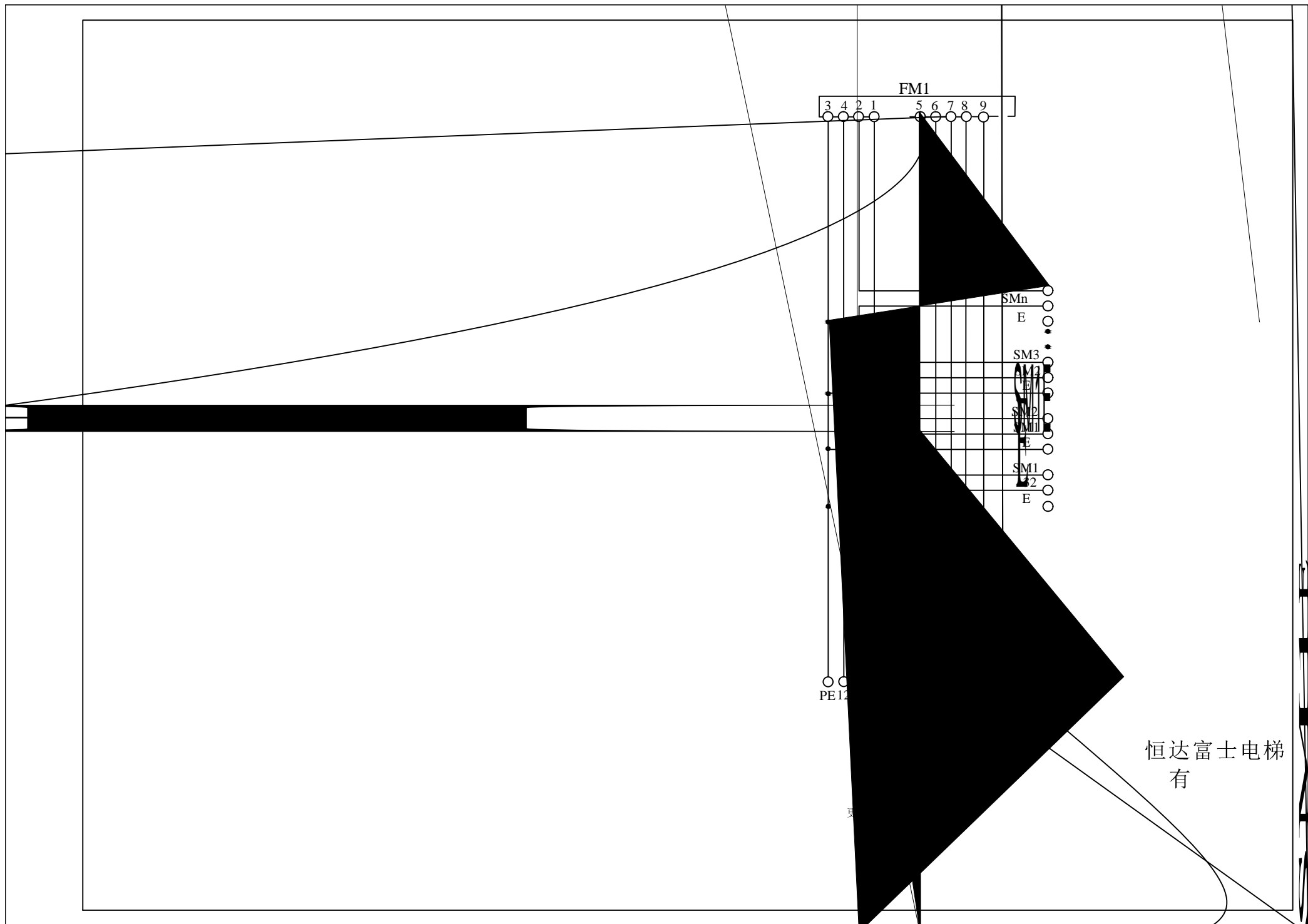

FM1

3 4 2 1 5 6 7 8 9

SMn

E

SM3

SM2

SM1

E

SM1

E

PE12

恒达富士电梯  
有

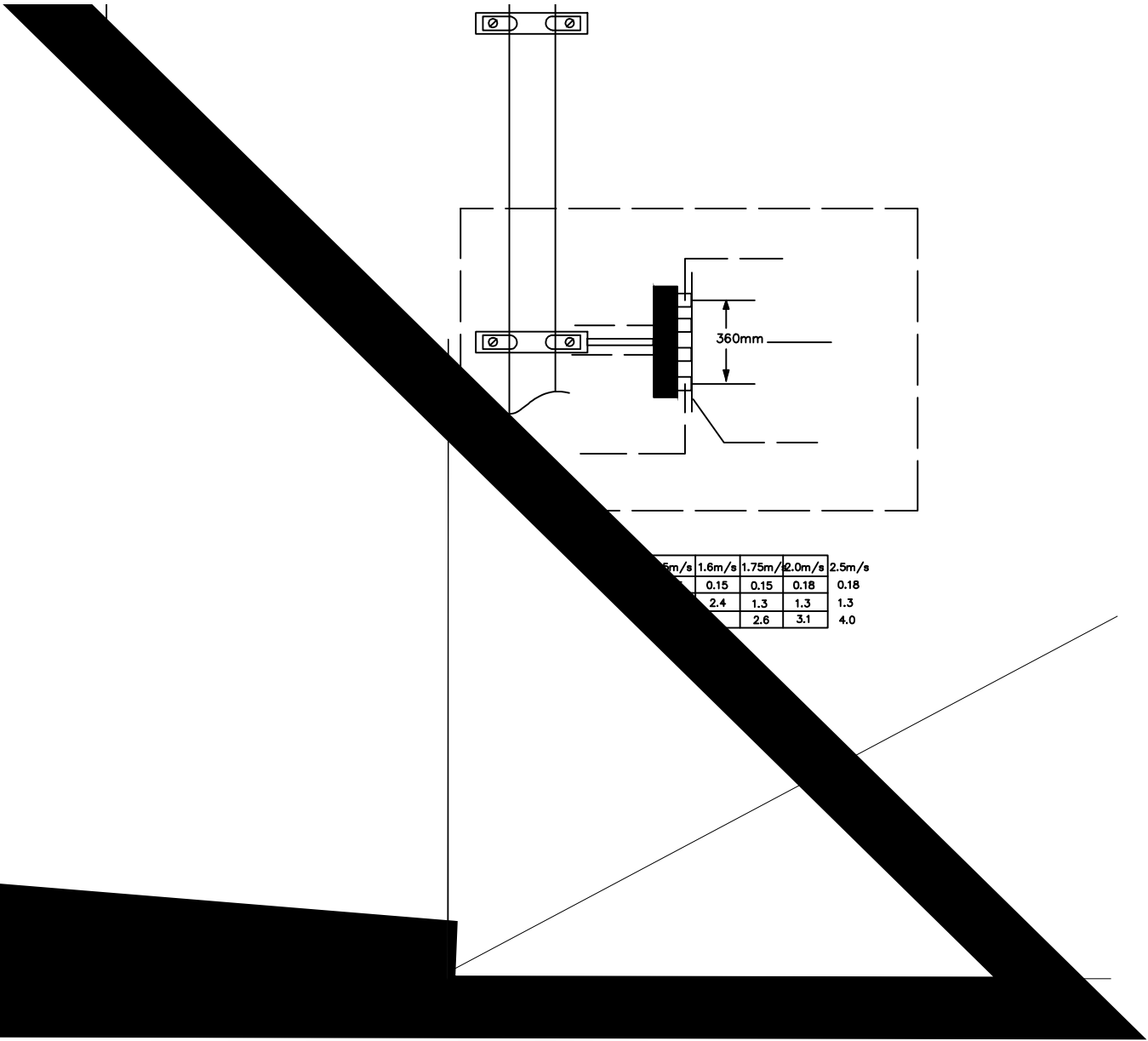

1.6m/s	1.6m/s	1.75m/s	2.0m/s	2.5m/s
0.15	0.15	0.18	0.18	0.18
2.4	1.3	1.3	1.3	1.3
	2.6	3.1		4.0